

Lock valve Spring loaded check valve

$Q_{\max} = 600 \text{ l/min}$, $p_{\max} = 420 \text{ bar}$

poppet type

Type series: RVSAE3/6DS-11/4"-...



- For SAE flange ports
- High pressure rating
- Compact construction
- No-flow direction can be reversed
- The same valve body is used for 3000 psi and 6000 psi ports
- Optional metered flow in the no-flow direction
- Double-sided sealing

Description

Check valves for SAE flange ports are characterized by very high load capacity and very small pressure rise. The valve can be used without modification on both 3000 psi (210 bar) and 6000 psi (420 bar) SAE flange ports. The no-flow direction can be reversed by inverting the valve. The valve design is based on a guided

poppet that is hardened and ground. In the no-flow direction, the valve closes. The valve can be used for pressure relief in the opening direction, but only to a limited extent (consult Bucher Hydraulics for such applications). The valve is available in nominal sizes $\frac{3}{4}$ ", 1", 1 $\frac{1}{4}$ ", 1 $\frac{1}{2}$ " and 2".

Symbol

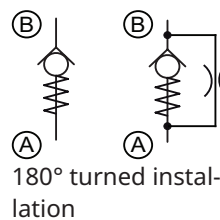
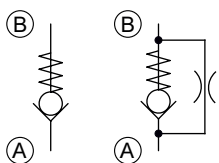

Technical data

General characteristics	Description, value, unit
Function group	Lock valve
Function	Spring loaded check valve
Characteristic	poppet type
Construction size	SAE 1 1/4"
Mounting attitude	unrestricted
Weight	0,73 kg

Hydraulic characteristics	Description, value, unit
Maximum operating pressure	420 bar
Maximum flow rate	600 l/min
Flow direction	see symbol
Hydraulic fluid	HL and HLP mineral oil according to DIN 51 524; other fluids on request!
Minimum fluid temperature	- 30 °C
Maximum fluid temperature	+ 80 °C
Viscosity range	10 ... 500 mm ² /s (cSt)
Minimum fluid cleanliness (cleanliness class according to ISO 4406:1999)	class 20/18/15
Opening pressure	0,2, 0,5, 1, 2, 4 bar

i **NOTE!**
For other values please contact Bucher Hydraulics.

Performance graphs

measured with oil viscosity 33.0 mm²/s (cSt)

$\Delta p = f(Q)$ Pressure drop-flow rate characteristic

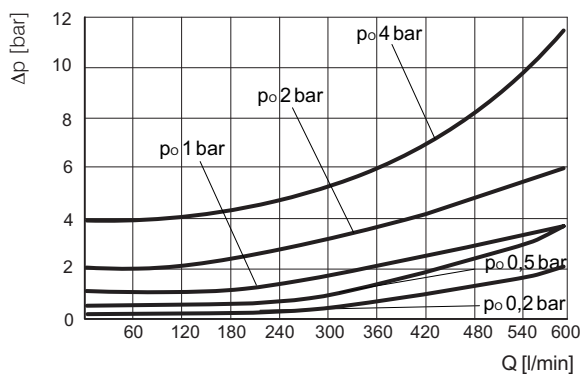

Dimensions and sectional view

Dimensions - valve

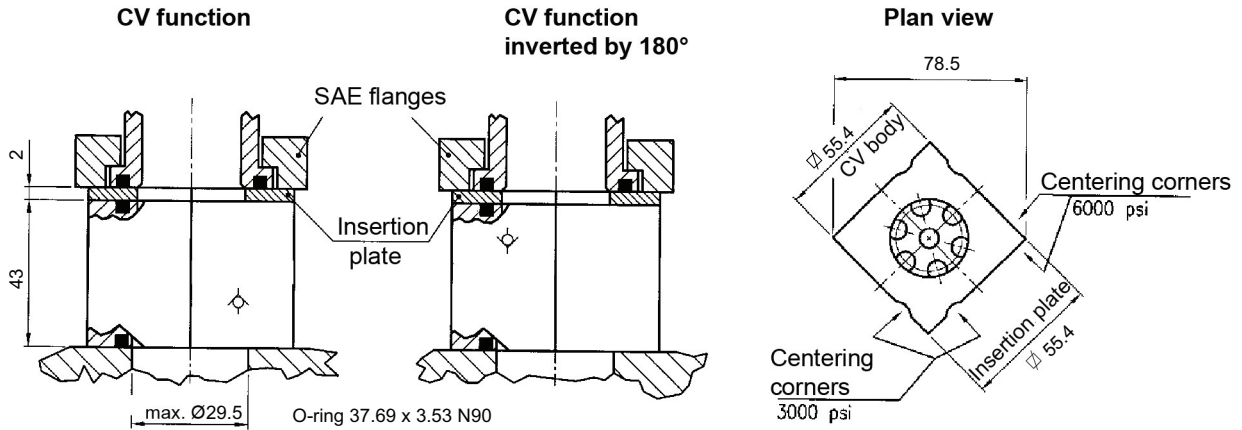

Dimensions - SAE flange ports

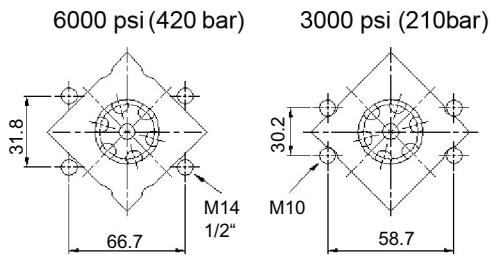

Minimum distance between 2 SAE check valves

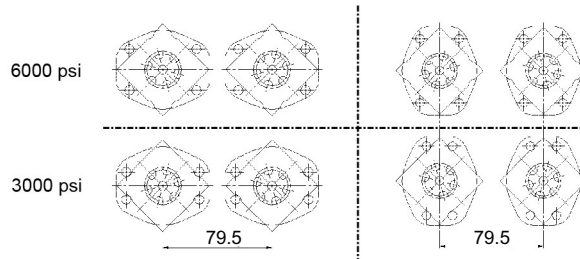

Installation information



NOTE!

The SAE flange mounting screws have to be tightened with the specified torque. The value can be found in the chapter technical data. By turning them through 90°, the RVSAE3/6... dual purpose bodies, the seal plates and insert plates can be used on both 3000 psi and 6000 psi ports of the same nominal size. Where a seal plate and an insert plate are added, it is seldom necessary to fit longer SAE flange connecting bolts. When you choose to add orifices or nozzles to the circuit they are to be placed after the check valve, if this is not possible, a right-angle bore must be designated between the check valve and the nozzle (see datasheet 170-P-059000).



ATTENTION!

When fitting the valve, make sure that it is firmly seated on the sealing surface and that it is not deformed by the use of excessive force.

Application Note



NOTE!

The maximum operating pressure must not be exceeded even when pressure peaks occur. In applications such as accumulator circuits, where sudden pressure can be applied to the valve in the free-flow direction, ensure that the specified flow ratings are not exceeded. Buyers bear the sole responsibility for ensuring that the valve is suitable for their applications and must be substantiated by trials or testing, if necessary.

Ordering code

RV SAE - - 114 - 02 - - -

RV = check valve

SAE = SAE-flange port (fits between port and flange)

3/6 = dual -purpose body 3000 psi / 6000 psi

DS = o-rings on both faces

DSZ = inclusive one insert plate

114 = Nominal size 1 1/4"

02 = opening pressure 0,2 bar

05 = opening pressure 0,5 bar

1 = opening pressure 1 bar

2 = opening pressure 2 bar

4 = opening pressure 4 bar

blank = without orifice

D1x... = with orifice (by consultation)

blank = nitrile (standard)

V = viton

On request:

- other opening pressures
- special materials
- customised designs

Ordering code for the associated insert plate:

170202330 = ZPSAE-114 (insert plate for check valve SAE 1 1/4")

Related data sheets

Reference	Description
170-P-059000	Using nozzles or orifices before a check valve