

Directional valve 4-way/2-position

$Q_{\max} = 30 \text{ l/min}$, $p_{\max} = 250 \text{ bar}$

switching solenoid, direct acting, spool type, switching position monitored

Type series: WK42APS_B5...

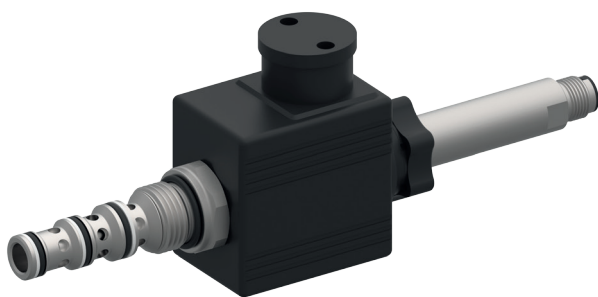

- Screw-in cartridge valve
- For cavity AN
- All external parts with zinc-nickel plating according to DIN EN ISO 19598
- Various plug-connector systems and voltages are available
- Installation in threaded port body type GANA
- The slip-on coil can be rotated, and it can be replaced without opening the hydraulic envelope
- High pressure wet-armature solenoids
- With integral electronic monitoring of operating position

Description

These 4/2 solenoid-operated cartridge valves, series WK42APSAB5..., feature monitoring of the operating positions and are size 5, direct acting, pressure balanced screw-in cartridges with an 3/4-16 UNF mounting thread. They are designed on the proven sliding-spool principle. The safe switch position is always the non-operated valve position. To ensure that electrical line interruptions of any kind do not result in unsafe conditions, the sensor's switch output is always at High in the non-operated state. The safe switch position is considered to have been reached when the spool is in the overlap state. As an option, the energized po-

sition can be controlled additionally. All external parts of the cartridge are zinc-nickel plated according to ISO EN DIN 19 598 and are thus suitable for use in the harshest operating environments. The slip-on coils can be replaced without opening the hydraulic circuit or removing the electronics (sensor) and can be positioned at any angle through 360°. These valves are primarily used in mobile and industrial applications as pilot valves for controlling the travel direction of actuators such as hydraulic motors and cylinders. If you intend to install the valve yourself, please refer to the section "Related data sheets".

Symbol

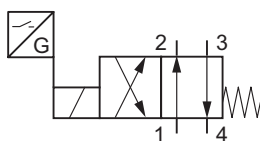

Simplified

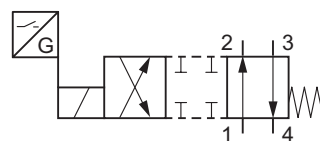

Detailed

Technical data

General characteristics	Description, value, unit
Sales category	project specific (on request)
Function group	Directional valve
Function	4-way/2-position
Design	Screw-in cartridge valve
Controls	switching solenoid
Characteristic	direct acting, spool type, switching position monitored
MTTFd value	150 years
Construction size	NG 5
Thread size	3/4-16 UNF-2A
Mounting attitude	unrestricted
Weight	0.59 kg
Cavity acc. factory standard	For cavity AN
Tightening torque steel	60 Nm
Tightening torque aluminium	60 Nm
Tightening torque tolerance	± 10 %
Minimum ambient temperature	- 30 °C
Maximum ambient temperature	+ 40 °C
Surface protection	All external parts with zinc-nickel plating according to DIN EN ISO 19598
Sealing material	see ordering code
Seal kit order number	NBR: DS-248-N / FKM: DS-248-V

Hydraulic characteristics	Description, value, unit
Maximum operating pressure	250 bar
Maximum flow rate	30 l/min
Flow direction	see symbol
Hydraulic fluid	HL and HLP mineral oil according to DIN 51 524; other fluids on request!
Minimum fluid temperature	- 30 °C
Maximum fluid temperature	+ 80 °C
Viscosity range	10 ... 500 mm ² /s (cSt)
Recommended viscosity range	15 ... 250 mm ² /s (cSt)
Minimum fluid cleanliness (cleanliness class according to ISO 4406:1999)	class 20/18/15

i NOTE!
 Slightly increased leakage is possible in dynamic use in the lowest temperature range.

i IMPORTANT!
 The maximum permissible ambient temperature is +50 °C (122 °F) with a relative duty cycle of 60% and a cycle time of 5 minutes.

Electric characteristics of the solenoid coil	Description, value, unit
Actuator type	solenoid coil
Solenoid coils type	36X48/16.1
Supply voltage DC	12/24 V DC
Supply voltage tolerance	± 10 %
Nominal power consumption	19 W
Switching time	Switching time measured at: U_N : $\Delta p = 200$ bar; $Q = 24$ l/min; $T_{Ambient} = 20$ °C; $\vartheta = 46$ mm ² /s 1 to 2; 3 to 4: 33 ms (energizing) / 75 ms (de-energizing) 1 to 3; 2 to 4: 60 ms (energizing) / 91 ms (de-energizing)
Relative duty cycle	100 %
Electrical connection coil	several connection types available, see ordering code
Protection class solenoid coil to ISO 20 653 / EN 60 529	several classes of protection available, see ordering code (with appropriate mating connector and proper fitting and sealing)

NOTE!

The switching time can be strongly dependent on flow rate, pressure, oil viscosity and the dwell time under pressure. In practice, the switching time may therefore deviate from the specified value range.

Electric characteristics of the sensor	Description, value, unit
Supply voltage (+Vs)	10...30 V DC
Maximum load current	100 mA
Short-circuit protection	Permanently resistant to load short circuit
Protection class sensor to ISO 20653 / EN 60529	IP 67 / IP 69K (with appropriate mating connector and proper fitting and sealing)
Vibration test	EN 60068-2-6 – 55 Hz, amplitude 1 mm, 3 axes, 30 min
Shock test	EN 60068-2-27 – half sine wave, 30 gn 11 ms half sine wave, 3 axes
EMC immunity	EN 61000-6-2
EMC interference emission	EN 61000-6-4
MTTF (40° C) according to EN ISO 13849-1 Annex C.5	320 years
MTTFD according to EN ISO 13849-1 Annex C.5.1	640 years
Electrical connection	device plug M12x1, 4-pin (male), A-coded

Performance graphs

measured with oil viscosity 33.0 mm²/s (cSt), coil at steady-state temperature and 10 % undervoltage

$p = f(Q)$ Performance limit

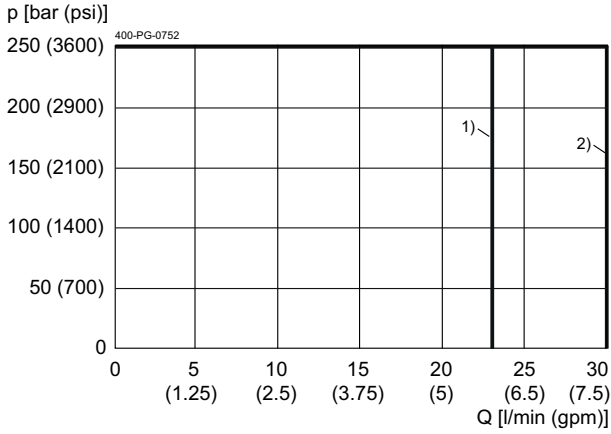

- 1) = 1 → 3; 2 → 4
- 3) = 1 → 2; 3 → 4

$\Delta p = f(Q)$ Pressure drop-flow rate characteristic

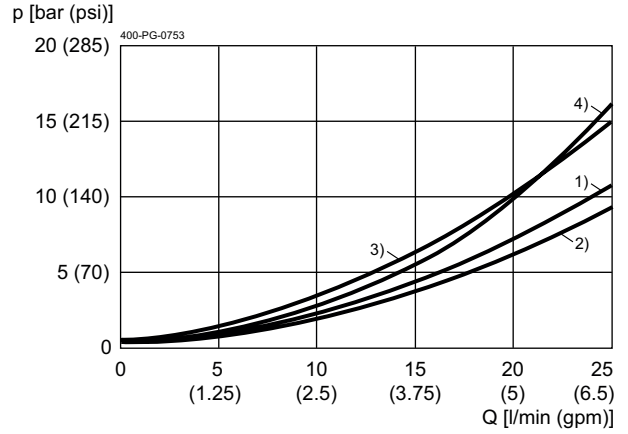

- 1) = 1 → 2
- 2) = 1 → 3
- 3) = 2 → 4
- 4) = 3 → 4

Dimensions and sectional view

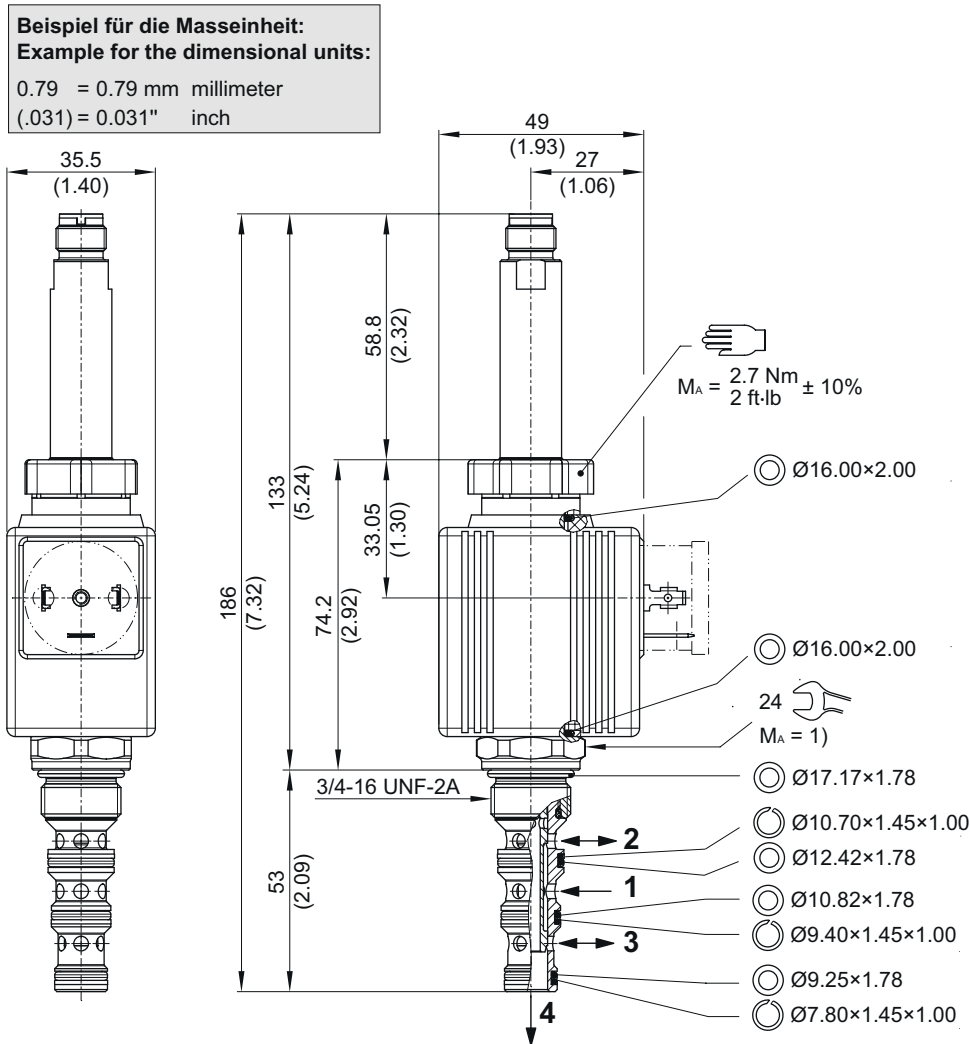

Installation information



ATTENTION!

Using screw-in valves and components that include monitoring of the operating position: do not use the signal from the position switch to directly activate a safety-related control function. In addition, only use solenoid coils that have a protection diode.



ATTENTION!

The safe switch position is the non-operated valve position. In accordance with the criteria for proven safety principles, the status of the position signal changes during the overlap stroke (before the valve actually opens).



ATTENTION!

Only qualified personnel with mechanical skills may carry out any maintenance work. Generally, the only work that should ever be undertaken is to check, and possibly replace, the seals. When changing seals, oil or grease the new seals thoroughly before fitting them.



NOTE!

1) When fitting the screw-in cartridge valve, use the specified tightening torque. The value can be found in the chapter "Technical data".



NOTE!

The seals are not available individually. The seal kit order number can be found in the chapter "Technical data".



IMPORTANT!

When connecting the sensor (for monitoring the operating position), note the information regarding pin assignment in this data sheet. The sensor cable must not be subjected to any pulling forces. Note also that opening the screw-in valve or removing the electronics (sensor) is not permitted!



NOTE!

To achieve the screw-in valve's maximum performance rating, fit the solenoid coil as shown (with the plug pins nearest the knurled nut). The valve must be installed in a steel body.

Connection diagram for sensor

Standard "A", 1 switching point:

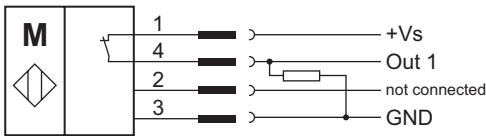

Option "B", 2 switching points:

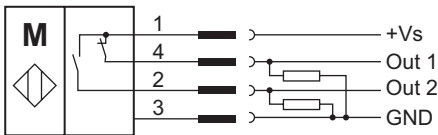

	Version A		Version B	
Valve status	Out 1	Out 2	Out 1	Out 2
Unactivated	high	-	high	low
Actuated	low	-	low	high

Ordering code

z. B.

W	K	42A	P	S	A	B	5	N	-	2	24	D	GR	_
---	---	-----	---	---	---	---	---	---	---	---	----	---	----	---

- W = directional valve
- K = spool-type, direct acting
- 42A = 4-way/2-position, A spool
- P = electrically operated, V DC = 19 W
- S = with operating-position monitoring
- A = PNP-normally closed, 1 switching point (**standard**)
- B = PNP-normally closed, 2 switching points (on request)
- A ... Q = standard model according to valid data sheet
- Z ... R = special model (on request)
- 5 = nominal size 5
- N = NBR (nitril-butadien-rubber / BUNA) seals (**standard**)
- V = FKM (fluorocarbon rubber / VITON) seals (special seals on request)
- 1 ... 9 = technical design no. (omit by ordering)
- ... = voltage e.g. 24 (24 V)
- D = current DC
- GR = plug connection to DIN EN (with protection diode, IP 65) (**standard**)
- JR = Junior-Timer radial plug connection (with protection diode, IP65)
- UR = Deutsch plug connection (with protection diode, IP 65)
- (blank) = without mating plug
- Q = with mating plug (only by connection type "GR" possible)

IMPORTANT!
Minimum order quantity of 500 pcs/year

Related data sheets

Reference	Description
400-P-040011	Form tools
400-P-010101	MTTFD Values for Hydraulic Valves
400-P-120212	Solenoid coil 36X48/16.1
400-P-040191	Cavity AN
400-P-720121	Threaded port body GANA

info.ch@bucherhydraulics.com

www.bucherhydraulics.com

© 2024 by Bucher Hydraulics AG Frutigen, 3714 Frutigen, Switzerland

All rights reserved.

Data is provided for the purpose of product description only, and must not be construed as warranted characteristics in the legal sense. The information does not relieve users from the duty of conducting their own evaluations and tests. Because the products are subject to continual improvement, we reserve the right to amend the product specifications contained in this catalogue.