

# Directional valve

## Bypass thermostat valve

$Q_{\max} = 120 \text{ l/min}$ ,  $p_{\max} = 50 \text{ bar}$

mechanically with thermostat element, integral relief function

Type series: WDTUVA-60-10...



- Screw-in cartridge valve
- For cavity DU
- All external parts with zinc-nickel plating according to DIN EN ISO 19598
- Oil warms up rapidly (cold-start phase)
- Direct-mounted in coolers or manifold blocks
- Low head loss
- Choice of various pressure settings
- Installation in threaded port body type GCUA
- Very good reproducibility
- Extremely reliable
- Very stable operation
- Temperature-dependent bypass control

### Description

These direct acting bypass thermostat valves are size 10, temperature controlled, high performance screw-in valves with an M27×2 mounting thread. They are intended to be installed directly in coolers or line-mounting body. Depending on the temperature of the oil, they route the flow either straight to tank or through the cooler. When the oil is cold ( $< 60 \text{ }^\circ\text{C}$ ), the connection P to T is open (bypass), which means that the flow is directed to tank with minimal headloss and the oil warms up rapidly. After the changeover temperature is reached ( $> 75 \text{ }^\circ\text{C}$ ), the integral thermostat element

closes the connection P to T. The valve now directs the oil flow through the cooler. With the integral pressure-relief function, the bypass thermostat valve also safeguards the cooler by protecting it from any pressure peaks that may result from excessive flow rates. The maximum pressure is determined by the model that is selected. The valves are predominantly used in coolers in mobile as well as industrial applications. All external parts of the valves are zinc-nickel plated and are thus suitable for use in the harshest operating environments.

### Symbol

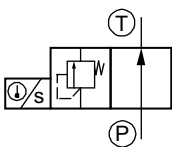

Technical data

General characteristics	Description, value, unit
Sales category	minimum order quantity required (see order details)
Function group	Directional valve
Function	Bypass thermostat valve
Design	Screw-in cartridge valve
Controls	mechanically with thermostat element
Characteristic	integral relief function
Construction size	NG 10
Thread size	M27×2
Mounting attitude	unrestricted
Weight	0.2 kg
Cavity acc. factory standard	For cavity DU
Tightening torque steel	60 Nm
Tightening torque aluminium	60 Nm
Tightening torque tolerance	± 10 %
Minimum ambient temperature	- 30 °C
Maximum ambient temperature	+ 100 °C
Surface protection	All external parts with zinc-nickel plating according to DIN EN ISO 19598
Sealing material	see ordering code

Hydraulic characteristics	Description, value, unit
Maximum operating pressure	50 bar
Maximum flow rate	120 l/min
Temperature for start of control action	60 °C
Flow direction	see symbol
Hydraulic fluid	HL and HLP mineral oil according to DIN 51 524; other fluids on request!
Minimum fluid temperature	- 30 °C
Maximum fluid temperature	+ 100 °C
Viscosity range	10 ... 650 mm <sup>2</sup> /s (cSt)
Recommended viscosity range	15 ... 250 mm <sup>2</sup> /s (cSt)
Minimum fluid cleanliness (cleanliness class according to ISO 4406:1999)	class 20/18/15

Performance graphs

measured with oil viscosity 33.0 mm<sup>2</sup>/s (cSt)

$\Delta p = f(T)$  Pressure drop-temperature

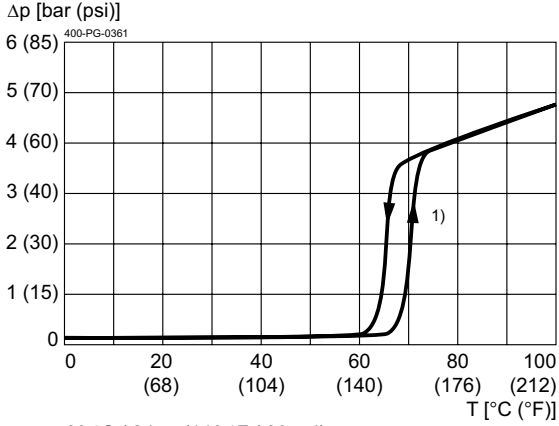

60 °C / 2 bar (140 °F / 30 psi)  
1) Q = 20 l/min (5 gpm)

$\Delta p = f(Q)$  Pressure drop-flow rate characteristic

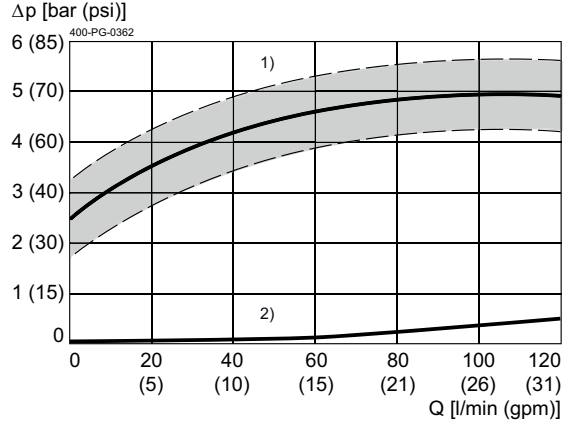

60 °C / 2 bar (140 °F / 30 psi)  
1) T = 75 °C (167 °F)  
2) T = < 50 °C (122 °F)

$\Delta p = f(T)$  Pressure drop-temperature

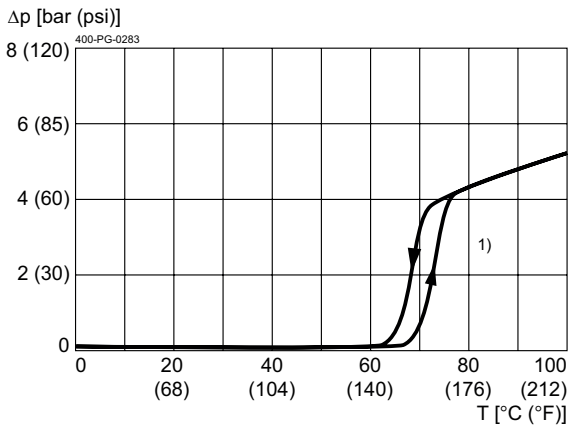

60 °C / 3 bar (140 °F / 40 psi)  
1) Q = 20 l/min (5 gpm)

$\Delta p = f(Q)$  Pressure drop-flow rate characteristic

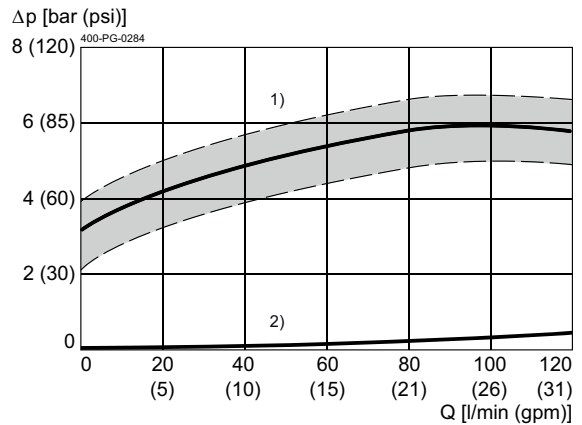

60 °C / 3 bar (140 °F / 40 psi)  
1) T = 75 °C (167 °F)  
2) T = < 50 °C (122 °F)

$\Delta p = f(T)$  Pressure drop-temperature

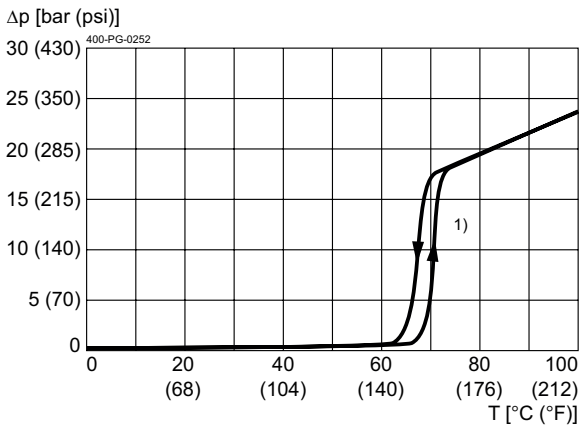

60 °C / 10 bar (140 °F / 140 psi)  
1) Q = 20 l/min (5 gpm)

$\Delta p = f(Q)$  Pressure drop-flow rate characteristic

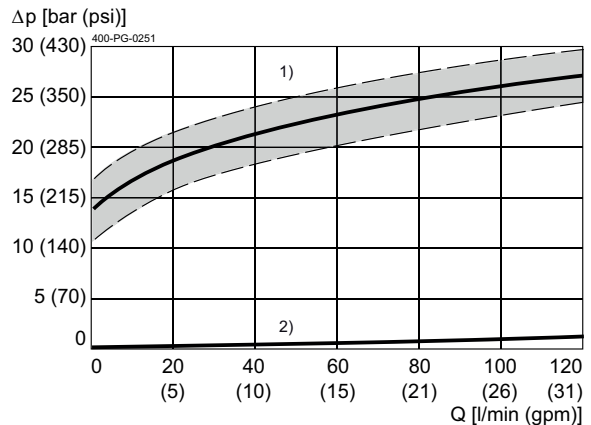

60 °C / 10 bar (140 °F / 140 psi)  
1) T = 75 °C (167 °F)  
2) T = < 50 °C (122 °F)

## Dimensions and sectional view

**Beispiel für die Masseinheit:**  
**Example for the dimensional units:**  
0.79 = 0.79 mm millimeter

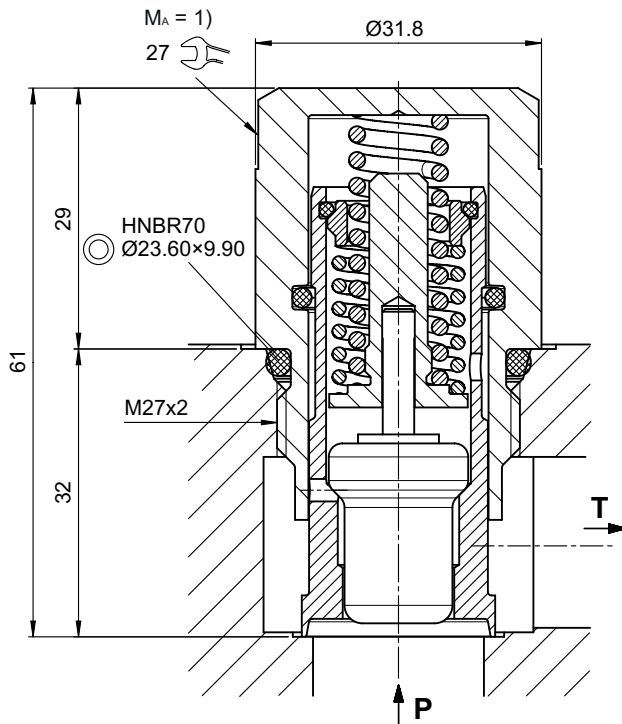

## Installation information

**i** **IMPORTANT!**  
1) When fitting the screw-in cartridge valve, use the specified tightening torque. The value can be found in the chapter "Technical data".

**!** **ATTENTION!**  
Only qualified personnel with mechanical skills may carry out any maintenance work. Generally, the only work that should ever be undertaken is to check, and possibly replace, the seals. When changing seals, oil or grease the new seals thoroughly before fitting them.

## Application examples

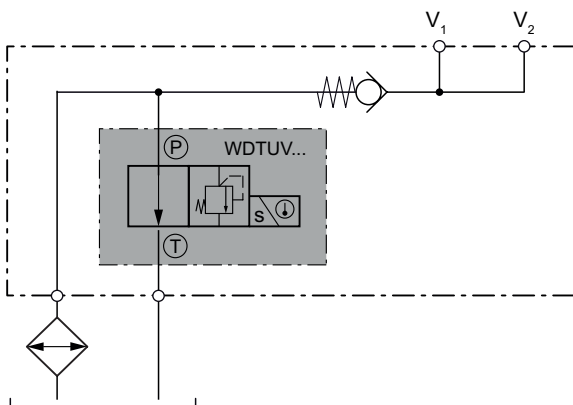

Manifold block with integral cooler-bypass thermostat valve

Ordering code

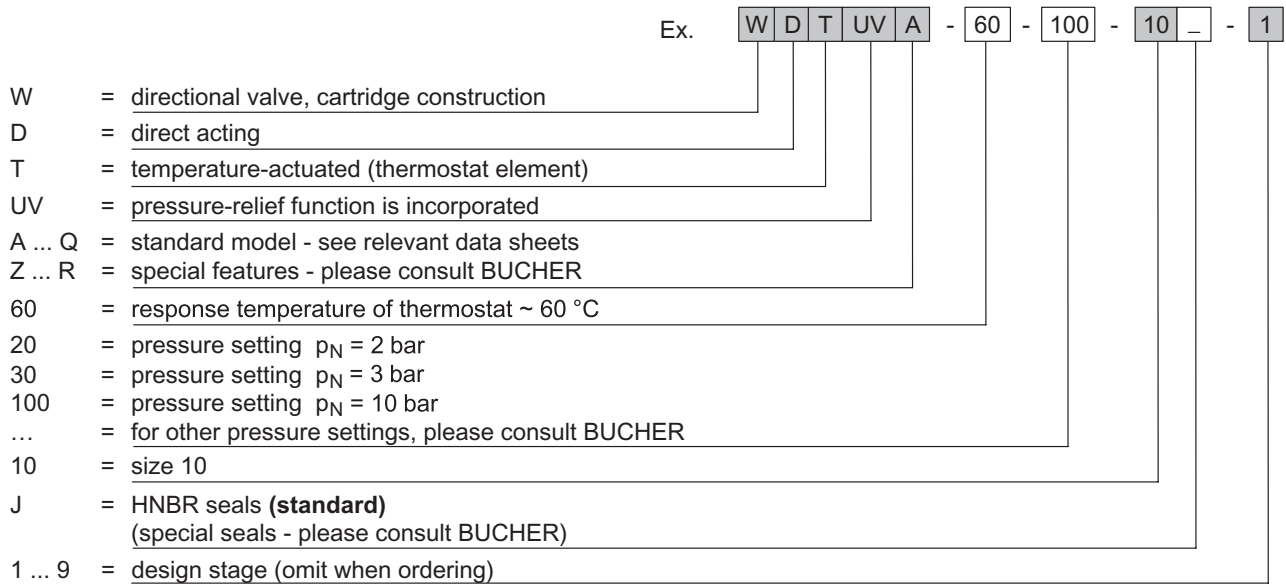

**IMPORTANT!**

Minimum order quantity of 500 pcs./year

Related data sheets

Reference	Description
400-P-040011	Form tools
400-P-060241	Cavity DU
400-P-740251	Threaded port body GCUA